

Modeling Code Lists

Ed Barkmeyer, NIST

7 March 2013

Problem

- Modeling Classifiers that have registered identifiers
- Examples:
 - diagnostic and treatment codes
 - hazardous material classifications
 - vehicle models
- Registered identifiers form a "Code List"

Codes and Code Lists

- Code = standardized name or identifier for an individual Thing
 - associated with a definition/description of the thing
 - names the thing as an instance of some Class
- Code List = a set of codes that identify instances of some Class
 - subject to change over time, as new Things are added to the class
 - can be a regulatory classification scheme
 - not necessarily comprehensive:
the Code List may correspond to the extension of a subclass
that is distinguished only by having members that have those codes

A Bad Model

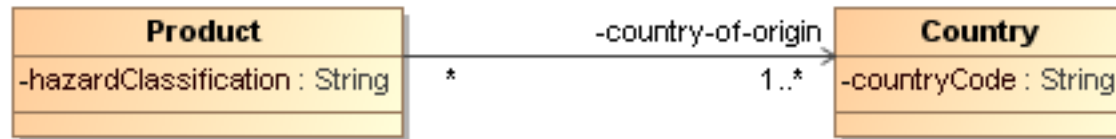

A Better Model

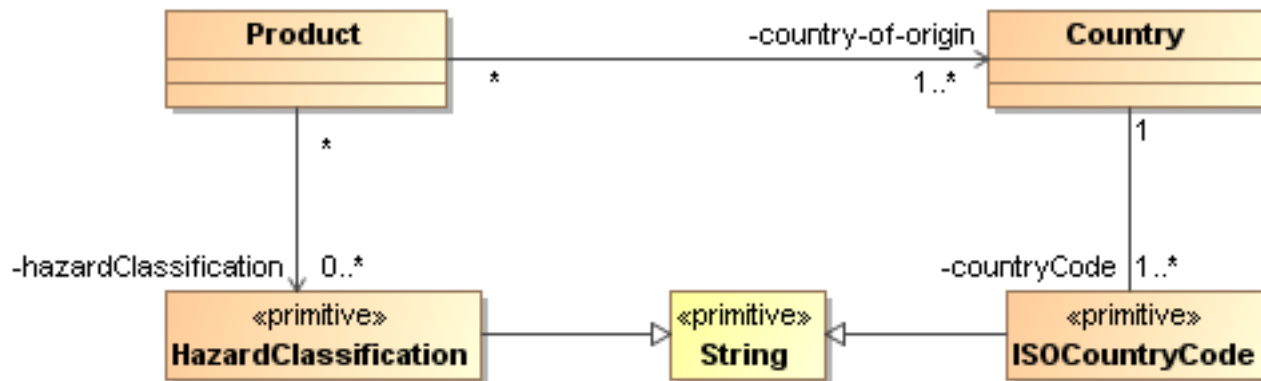

A Reference Model: ISO 11179

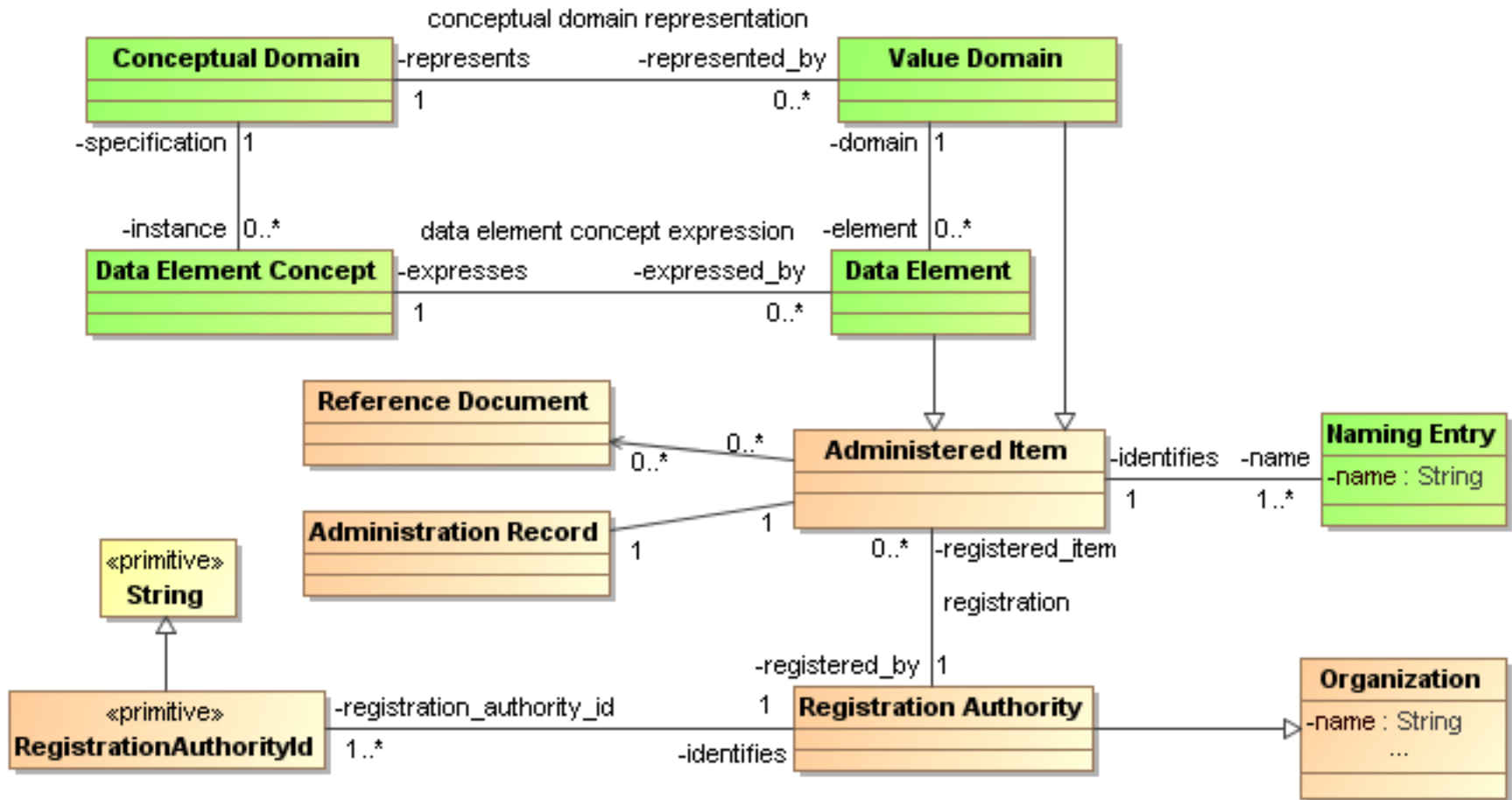

Simple Codes Model

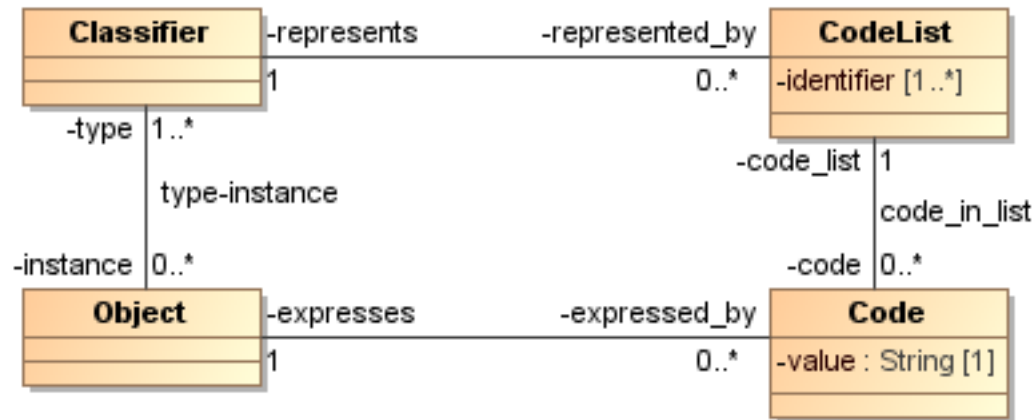

The Combination of Code value and CodeList identifier uniquely identifies a Code, and thus an individual Object within some Classification

Codes Model as ISO 11179

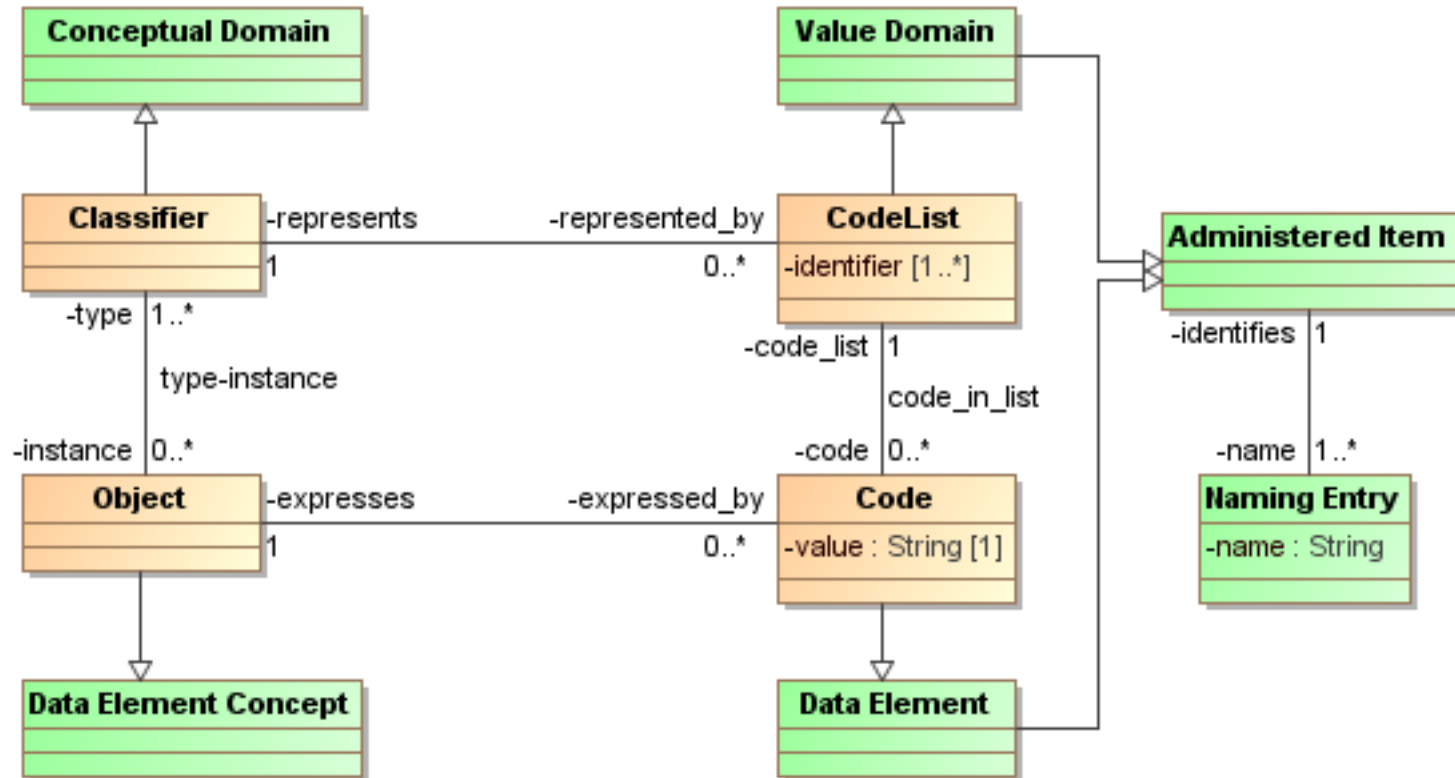

Example: Country Codes

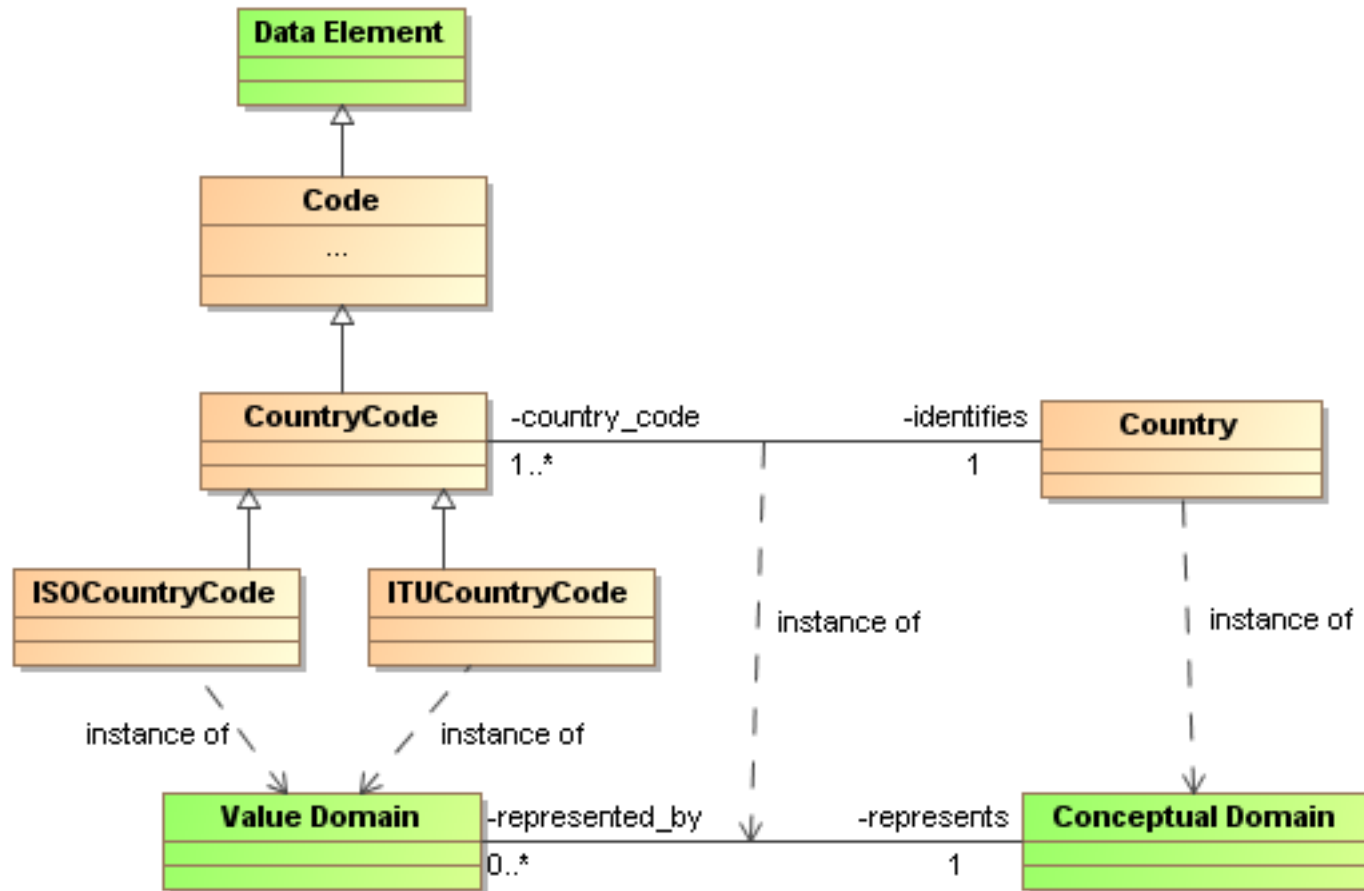

Example: Country Codes (definition)

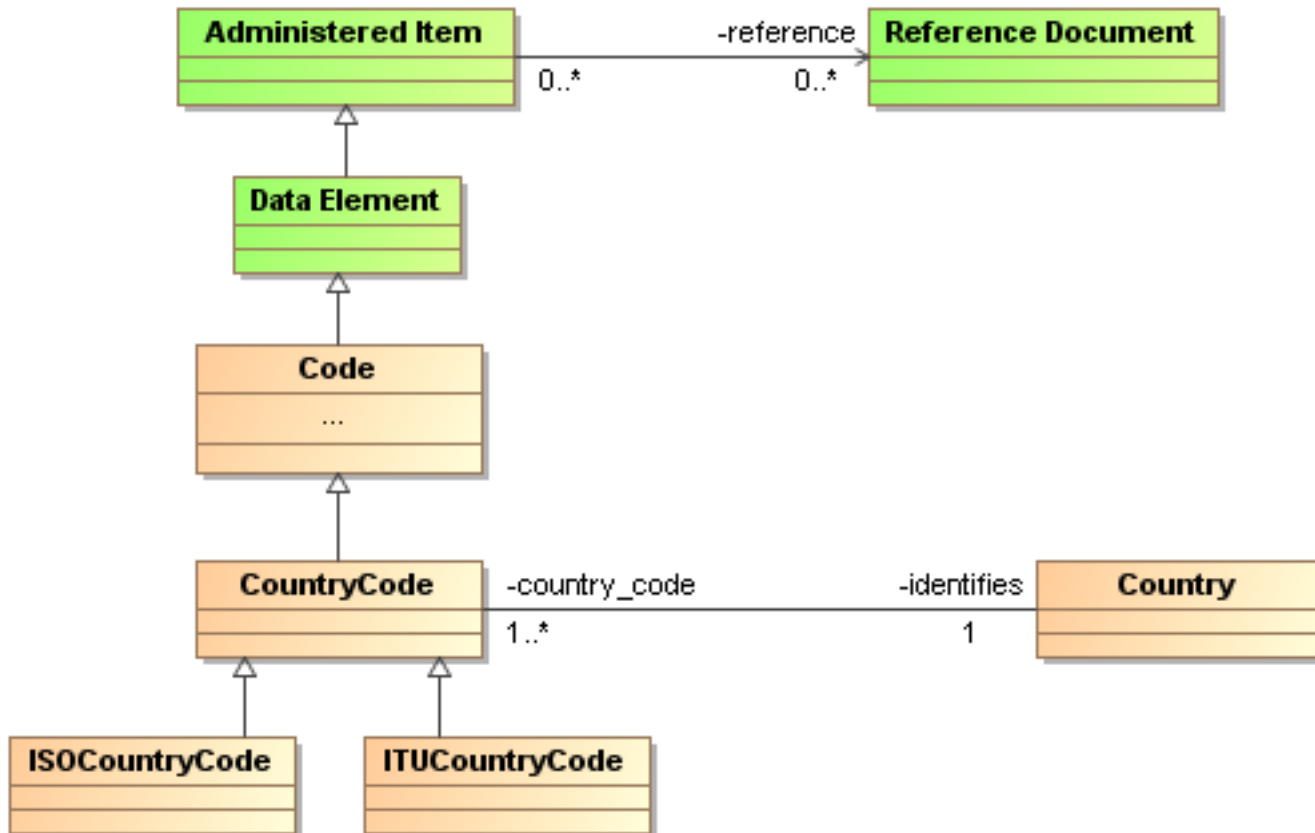

Example: Manufactured Parts

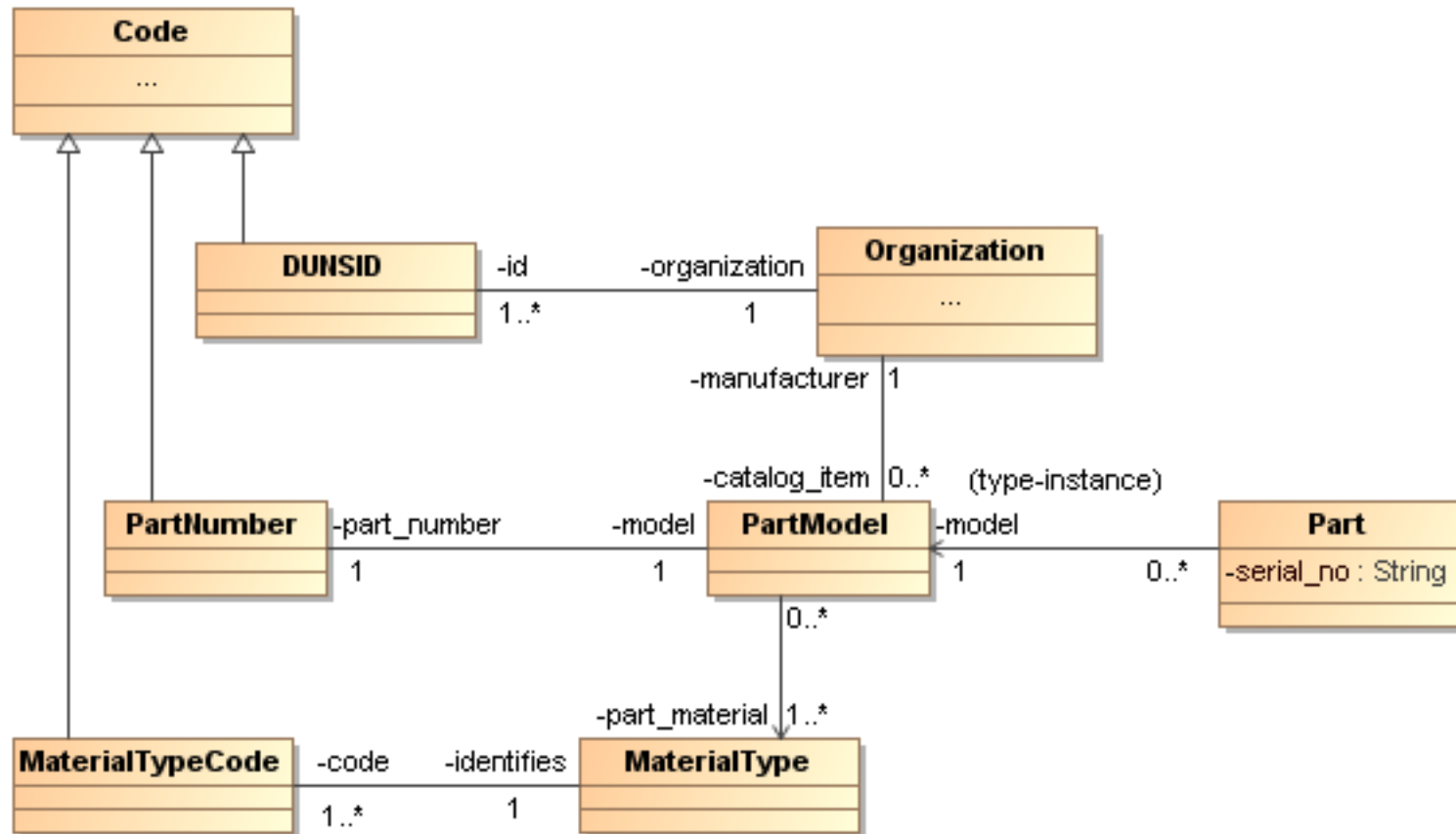

Example: Catalog as Registry

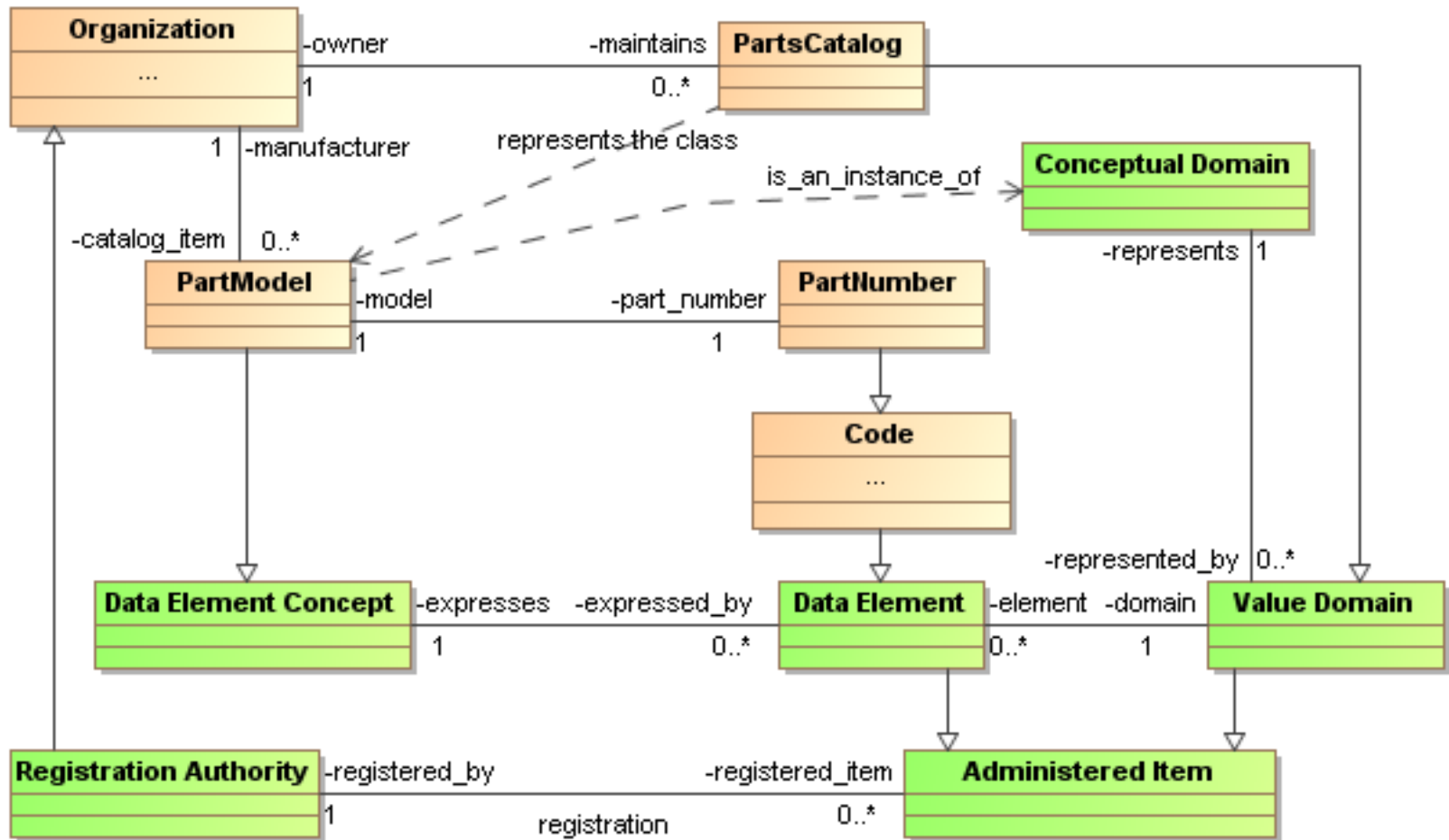

Summary

- The basic CodeList and Code model is a good model for identifiers
 - simple, but not simplistic
 - consistent with ISO 11179 standard for codes management
- The basic Codes model is extensible to (consistent with) other aspects of code management
 - definitions
 - synonyms
 - changes to the list
 - reference documents
 - registration authorities